

IP67

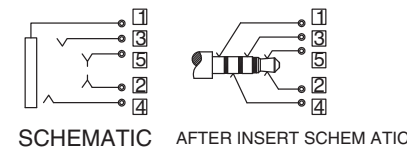
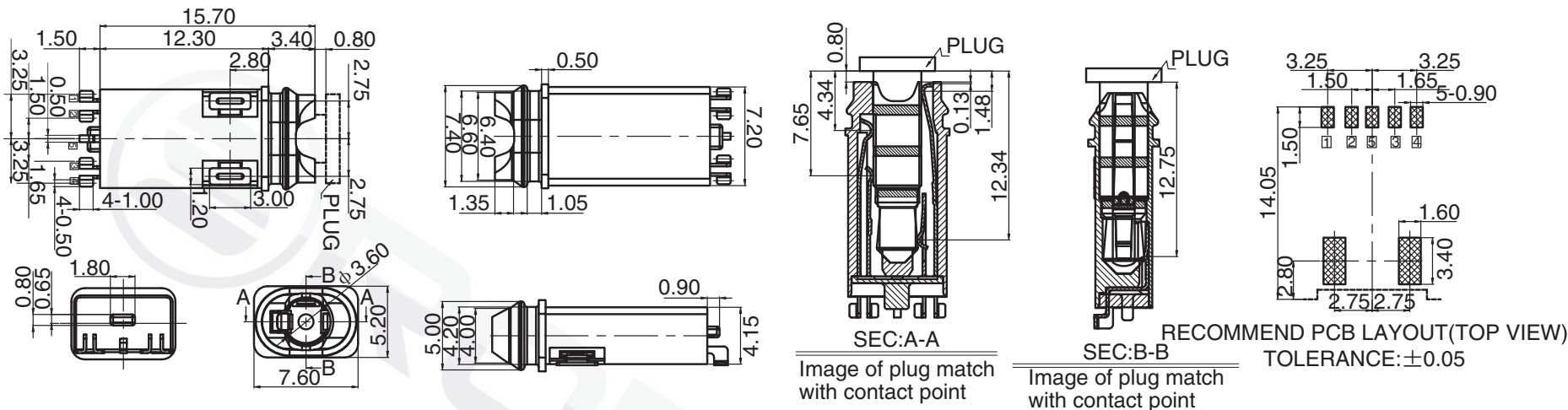

主要技术参数、性能
The Main Thchnology Performance

额定电流、电压 Rate voltage current	DC 30V 0.5A
接触电阻 Contact resistance	≤100mΩ
绝缘电阻 insulated resistance	≥100mΩ DC 500V
耐受电压 Withstand Voltage	AC 500V (50-60HZ)1min
电寿命 Electrical Life	5000 Cycles
使用温度 Service temperature	-25°C+80 °C
使用湿度 Ambient humidity used	≤85%RH
耐焊温度 Withstand Soldering temperature	260°C±5°C 5S±1S

E				
D				
C				
B				
A				
项目 ITEM	名称 DESCRIPTION	材质 MATERIAL	数量 QYT	表面处理/颜色 FINSH/COLOR

						第一视角 FIRST VIEW		名称/NAME: 耳机插座 PHONE JACK SERIES	
								型号/MODEL: PJ391	
标记 SING	处数 FREQUENCY	更改文件号 REVISION	签名 APPROVED	日期 DATE	比列 SCALE	一般公差 GENERAL TOLERANCE			
设计 DESIGN		Zhaoming			单位 UNIT	mm	0.5~2	±0.10	
审核 CHECKED		Zengyong			重量 WELGHT		2~5	±0.15	
批准 APPROVED		Fuyunfeng					5~10	±0.20	
							角度 ANGLE	±0.5°	